

MC 4-Light Travel Kit

Product Manual

English

Foreward

Thank you for purchasing the Aputure MC 4-Light Travel Kit.

Instructions

- Please read this product manual carefully.
- Keep this product manual and always include it when passing the product onto third parties.
- WARNING:** Do not place the product near any corrosive chemicals. Corrosion may cause the product to malfunction.
- Only use a microfiber or dry cloth to clean the product.
- Be careful to not damage the light by dropping it or otherwise introducing physical shock.
- Do not leave the product in excessive heat, high temperatures can cause the product to malfunction.
- Please have the product checked by the authorized service or agent if your product has some problems. Please note that this warranty does not apply to repair arising out of the malfunction of unauthorized disassembly, although you may request such repairs on a chargeable basis.
- Use of original Aputure cable accessories is recommended. Please note that this warranty does not apply to repairs arising out of the malfunction of non-original Aputure accessories, although you may request such repairs on a chargeable basis.
- The product is certificated by RoHS, CE, KCC and Japan MIC etc. Please operate the product in full compliance with the operation standards. Please note that this warranty does not apply to repair arising from malfunction, although you may request such repairs on a chargeable basis.
- The instructions and information in this manual are based on thorough, controlled company testing procedures. Further notice will not be given if the design and specifications change.

Intended Use

Intended use of the Aputure MC 4-Light Travel Kit includes:

- The user has read the instructions of this manual.
- The user is using the products within the operating conditions and limitations described in this product manual.
- "Improper use" means using the products other than as described in these instructions or under operating conditions which differ from those described herein.

Item Check List

Package includes the following items:

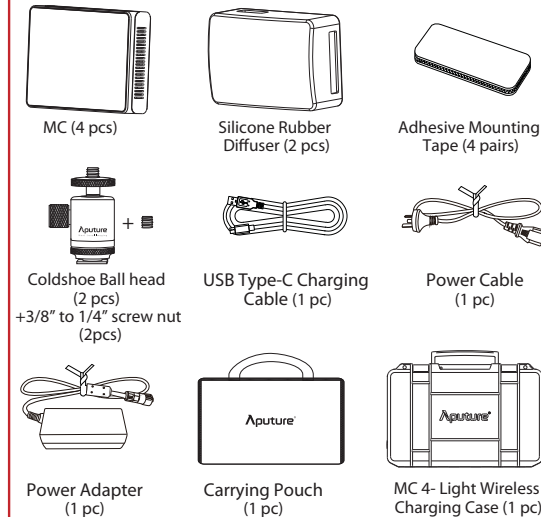

Product Details

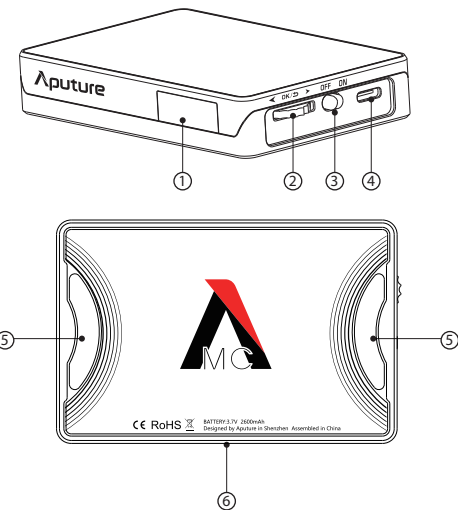

- 1 OLED Screen
- 2 Function Control Wheel
- 3 Power Switch
- 4 USB Type-C Charging Port
- 5 Magnets
- 6 1/4"-20 Screw Mount

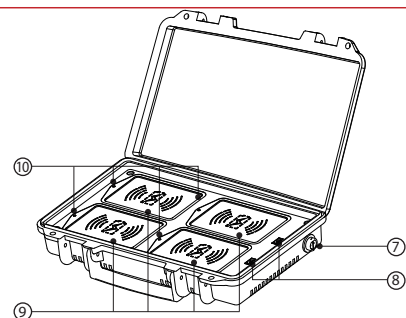

- 7 DC IN
- 8 USB Type-A Outputs
- 9 Wireless Charging Areas
- 10 Status Leds

Operation Instructions

1. Power Supply Installation

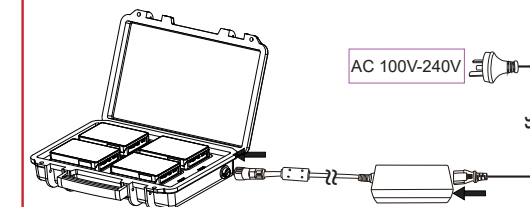

* Rotate the DC plug counterclockwise to detach the power adapter.

2. Charging

1). Wireless charging
The MC is compatible with the Qi wireless charging protocol. After the power is turned on, the MC can be wirelessly charged by placing the MC on the wireless charging area. The status led of the wireless charging case is always red, indicating that it is charging, and it is full when it is green.

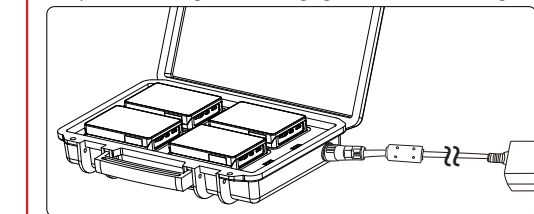

- * The status led flashes red to indicate that there is a metal foreign object on the wireless charging area.
- * Charge the light after powering the device off for optimal charging. Charging the device while the light is powered on will decrease its charging speed.
- * Don't charge the device when the charging case is closed to prevent overheating.

2). Type-C charging

As the light is charging, the on-screen battery level indicator will animate to show the battery's status. After the battery is fully charged, the battery level indicator will be displayed as full.

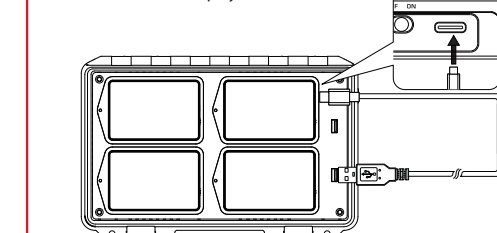

- * The MC supports 5V/2A charging via power brick or power bank.
- * The MC supports quick charging via USB-C PD protocol.
- * Charging is slow when the light is powered on. Turn the light off for optimal charging.
- * The MC on-screen battery indicator will flash when the battery level is too low.

3. MC Power ON/OFF

Adjust the position of the power switch to turn the light on or off.

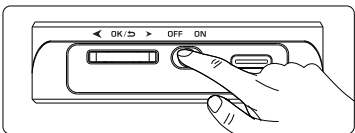

4. MC CCT Mode

Press and hold the control wheel for 2 seconds to access the system menu. Rotate the control wheel to select CCT and press the wheel to enter CCT mode. In CCT Mode, rotate the control wheel to adjust the color temperature between 3200-6500K. "Short press" the wheel to select intensity (INT) control, and turn the wheel to adjust the brightness level from 0-100%.



* Access more fine control via the Sidus Link mobile application.

5. MC HSI Mode

Press and hold the control wheel for 2 seconds to access the system menu. Rotate the control wheel to select HSI and press the wheel to enter HSI mode. In HSI Mode, "short press" the control wheel to toggle between HUE/SAT (saturation)/INT (intensity) controls. When controlling HUE, rotate the control wheel to adjust the hue color from 0-360°. When controlling saturation (SAT), turn the control wheel to adjust the color saturation between 0-100%. When controlling intensity (INT), turn the wheel to adjust the brightness level between 0-100%.



6. MC FX Mode

Press and hold the control wheel for 2 seconds to access the system menu. Rotate the control wheel to select FX and press the wheel to enter FX mode. In FX mode, rotate the control wheel to toggle between different lighting FX presets: Paparazzi, Fireworks, Faulty Bulb, TV, Lightning, Party, Pulsing, Cop car, & Fire. Once you have selected your desired lighting effect, "short press" the control wheel to access intensity (INT) control. Rotate the control wheel to adjust the brightness of the lighting effect from 0-100%.

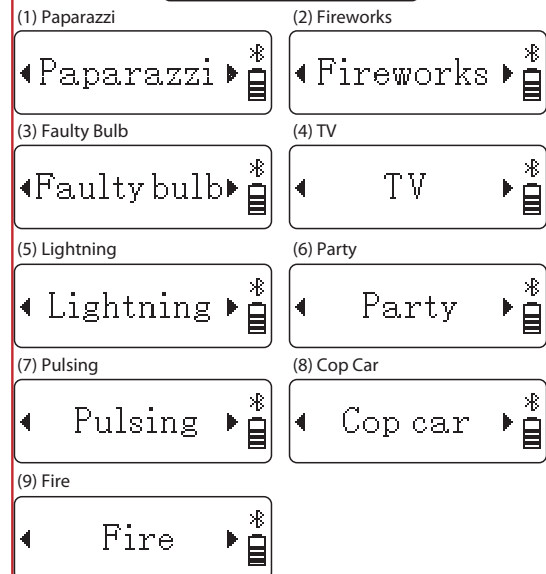

7. MC Bluetooth Mode

Press and hold the control wheel for 2 seconds to access the system menu. Rotate the control wheel to select BT and press the wheel to the Bluetooth Reset menu. Rotate the control wheel to select "YES" and short press the wheel to reset the device's Bluetooth pairing, (the pop-up window displays the current reset progress. The reset process completes within 5 seconds.) or select "NO" to return to the system menu.

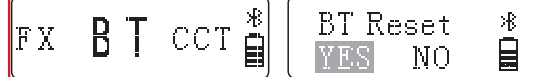

8. Attaching the Silicone Diffuser

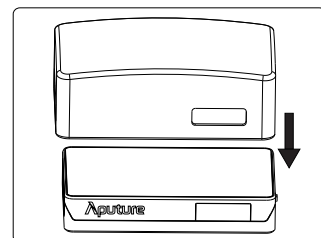

9. Using the Mounting Tape

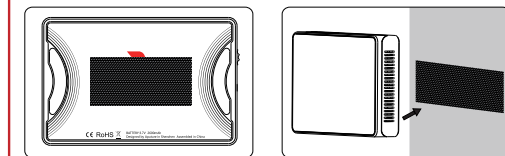

10. Using the Magnets

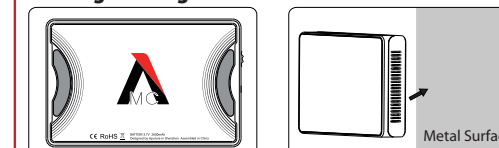

* Don't attach this device or the magnets to any surface with a temperature above 80°C. Doing otherwise can damage the magnets.

11. Using the Sidus Link APP

You can download the Sidus Link APP from the iOS App Store or Google Play Store for enhancing the functionality of the light. Please visit sidus.link/app/help for more details regarding how to use the app to control your Aputure lights.



Specifications

MC		3200-6500K	
Color Temperature	CRI	96+	
	TLCI	97+	
	Distance	0.3M	0.5M
Illuminance	Maximum Brightness	1100 lux	400 lux
		100 lux	
Battery Type	Lithium-polymer Battery (3.7V 2600mAh)		
Rated Output Power	5W		
Operating Temperature	0°C to 45°C		
Operating Battery Life	Max Brightness	Min Brightness	
	>2hrs	>15hrs	
	~1.5 hours via USB PD	~2 hours via USB DC 5V/2A	
Battery Recharge Time	~3.5 hours via wireless charging		
	93x61x17mm/3.66x2.40x0.67in		
Dimension			

* These are average results, the specific lux values may vary slightly between each lighting fixture.

Wireless Charging Case

Power Supply	DC 12V~16.8V
Rated Current	4.8A
Power Input	72W
Max Power Output	60W
Max Wireless Charging Power Output	4x10W
Dimension	283x188x61mm/11.14x7.4x2.4in

Detailed product manual for MC 4-Light Travel Kit can be found on www.aputure.com

Aputure GUARANTEE CARD

Aputure Imaging Industries Co., Ltd. warrants the original consumer purchaser from defects in material and workmanship for a period of one (1) year after the date of purchase. For more details of warranty, visit www.aputure.com

Important: Keep your original sales receipt. Be sure the dealer has written on it the serial No. of the product. This information is required for warranty service.

This warranty does not cover:

- Damage that is the result of misuse, abuse, accident (including but not limited to damage by water, faulty connection, defective or counterfeit accessories, or the use of the product with equipment not approved by Aputure).
- Cosmetic defects that appear more than thirty (30) days after the date of purchase. Cosmetic damage caused by improper handling is also excluded.
- Damage that occurs while the product is being shipped to wherever will service it.

The warranty is void if:

- The product identification or serial No. label is removed or defaced in any way.
- The product is serviced or repaired by any one other than Aputure or an authorized Aputure dealer or service agency.

Aputure Imaging Industries Co., Ltd.
 Add: 1/2, Building 21, Changjun Industrial Estate,
 Huihuo Road, Shuangzhen, Shuangzhen, Guangdong
 E-MAIL: info@aputure.com
 Sales Contact: (86)07543285696413

Service Warranty (EN)

Serial No. _____

Item Name _____

Purchase Date _____

Buyer Name _____

Buyer Phone _____

Buyer Add _____

Franchiser Seal _____